

INSTRUCTION MANUAL

MW180 MAX

pH / mV / EC / TDS / NaCl / Temperature
Bench Meter





THANK YOU for choosing Milwaukee Instruments!

This instruction manual will provide you the necessary information for correct use of the meter.

All rights are reserved. Reproduction in whole or in part is prohibited without the written consent of the copyright owner, Milwaukee Instruments Inc., Rocky Mount, NC 27804 USA.

TABLE OF CONTENTS

1. PRELIMINARY EXAMINATION	5
2. INSTRUMENT OVERVIEW	5
3. SPECIFICATIONS	6
4. FUNCTIONAL & DISPLAY DESCRIPTION	8
5. PROBE DESCRIPTION.....	11
6. GENERAL OPERATIONS.....	14
6.1. POWER CONNECTION & BATTERY MANAGEMENT	14
6.2. MOUNTING THE ELECTRODE HOLDER	14
6.3. CONNECTING THE PROBES	15
6.4. ELECTRODE CARE & MAINTENANCE.....	16
7. SETUP	20
7.1. MEASUREMENT MODES	20
7.2. GENERAL SETUP OPTIONS.....	21
7.3. pH MODE SETUP OPTIONS.....	25
7.4. EC MODE SETUP OPTIONS	27
8. pH	31
8.1. PREPARATION	31
8.2. CALIBRATION	31
8.3. MEASUREMENT	34
8.4. WARNINGS & MESSAGES.....	35
9. ORP	39
9.1. PREPARATION	39
9.2. MEASUREMENT.....	39
10. EC / TDS.....	40
10.1. PREPARATION	40
10.2. CALIBRATION	40
10.3. MEASUREMENT.....	42
10.4. WARNINGS & MESSAGES.....	44

11. SALINITY.....	46
11.1. PREPARATION	46
11.2. CALIBRATION	46
11.3. MEASUREMENT	47
11.4. WARNINGS & MESSAGES	49
12. LOGGING.....	51
12.1. TYPES OF LOGGING	52
12.2. DATA MANAGEMENT	54
13. GLP	61
14. TROUBLESHOOTING.....	62
15. ACCESSORIES.....	63
CERTIFICATION.....	64
RECOMMENDATION	64
WARRANTY.....	65

1. PRELIMINARY EXAMINATION

Each bench meter is delivered in a cardboard box and is supplied with:

- **MA917B/1** Double junction refillable pH electrode
- **MA814DB/1** – 4-ring EC/TDS/NaCl/Temperature probe
- **MA831R** Stainless steel temperature probe
- **M10004** pH 4.01 buffer solution (sachet)
- **M10007** pH 7.01 buffer solution (sachet)
- **M10010** pH 10.01 buffer solution (sachet)
- **M10031** 1413 $\mu\text{S}/\text{cm}$ conductivity calibration solution (sachet)
- **M10016** Electrode cleaning solution (sachet)
- **MA9315** Electrode holder
- Graduated pipette
- 12 VDC adapter
- USB cable
- Instrument quality certificate
- Instruction manual

2. INSTRUMENT OVERVIEW

MW180 is a compact and versatile bench meter that can measure up to six different parameters – pH, ORP, EC, TDS (Total Dissolved Solids), percentage of salinity (NaCl%) and temperature in a variety of ranges.

pH calibration can be performed in up to 5-point (using a selection of 7 standard calibration buffers and two custom buffers), to improve measurement reliability even when testing samples with wide differences in pH.

The auto-ranging feature for both EC and TDS measurements automatically sets the most suitable resolution for the tested sample. All measurements can be automatically (ATC) or manually temperature compensated (MTC) with a user-selectable compensation coefficient. The temperature compensation can be disabled if the actual conductivity value is required (No TC).

Available log space for two sets of up to 1000 records. Logged data can be exported using a USB cable.

MW180 has a dedicated GLP key to store and recall data on system status.

3. SPECIFICATIONS

	Range	Resolution	Accuracy @ 25 °C (77 °F)	Calibration
pH	-2.00 to 20.00 pH	0.01 pH	±0.01 pH	Up to 5-point automatic pH calibration, 7 standard calibration buffers: pH 1.68, 4.01, 6.86, 7.01, 9.18, 10.01 and 12.45 Two custom buffers
	-2.000 to 20.000 pH	0.001 pH	±0.002 pH	
ORP	±2000.0 mV	0.1 mV	±1 mV	
EC	0.00 to 29.99 µS/cm	0.01 µS/cm	±1% of reading (±0.05 µS/cm or 1 digit, whichever is greater)	Single cell factor calibration 6 standards: 84 µS/cm, 1413 µS/cm, 5.00 mS/cm, 12.88mS/cm, 80.0mS/cm, 111.8 mS/cm
	30.0 to 299.9 µS/cm	0.1 µS/cm		
	300 to 2999 µS/cm	1 µS/cm		
	3.00 to 29.99 mS/cm	0.01 mS/cm		
	30.0 to 200.0 mS/cm up to 500.0 mS/cm absolute conductivity*	0.1 mS/cm		
TDS	0.00 to 14.99 ppm (mg/L)	0.01 ppm	±1% of reading (±0.03 ppm or 1 digit, whichever is greater)	One-point offset: 0.00 µS/cm
	15.0 to 149.9 ppm (mg/L)	0.1 ppm		
	150 to 1499 ppm (mg/L)	1 ppm		
	1.50 to 14.99 g/L 15.0 to 100.0 g/L up to 400.0 g/L absolute TDS* (with 0.80 factor)	0.01 g/L 0.1 g/L		
Salinity	0.0 to 400.0 % NaCl	0.1% NaCl	±1% of reading	one-point with MA9066 Salinity calibration solution
	2.00 to 42.00 PSU	0.01 PSU		
	0.00 to 80.00 g/L	0.01 g/L		
Temperature	-20.0 to 120.0 °C (-4.0 to 248.0 °F)	0.1 °C (0.1 °F)	±0.5 °C (±0.9 °F)	
Temperature compensation	ATC – automatic, from -20 to 120 °C (-4 to 248 °F) MTC – manual, from -20 to 120 °C (-4 to 248 °F) NO TC – without temperature compensation			
Conductivity temperature coefficient	0.00 to 6.00 % / °C (EC & TDS only) Default value: 1.90 % / °C			
TDS factor	0.40 to 0.80, Default value: 0.50			
Logging memory	Two independent storage spaces. Each save location can contain max. 1000 log records (stored in up to 100 lots). On demand, 200 logs; on stability, 200 logs; interval logging, 1000 logs			

* Absolute conductivity (or TDS) is the conductivity (or TDS) value without temperature compensation.

PC connectivity	1 USB port, 1 micro USB port
Power supply	12 VDC adapter (included)
Battery type	internal
Battery life	8 hours
Environment	0 to 50 °C; maximum RH 95%
Dimensions	230 x 160 x 95 mm (9.0 x 6.3 x 3.7")
Weight	0.9 kg (2.0 lb.)
Warranty	3 years

PROBE SPECIFICATIONS

pH electrode MA917B/1	pH range	0 to 14 pH
	Temperature range	0 to 70 °C (32 to 158 °F)
	Operating temperature	20 to 40 °C (68 to 104 °F)
	Reference electrolyte	KCl 3.5M
	Reference junction	Ceramic, single
	Reference type	Double, Ag/AgCl
	Maximum pressure	0.1 bar
	Body	Glass; tip shape: sphere
	Connector	BNC
	Dimensions	Shaft length: 120 mm (5.5"); Ø 12 mm (0.5")
Cable	Length 1 m (3.2 ft)	
EC/TDS/NaCl probe MA814DB/1	Temperature range	0 to 60 °C (32 to 140 °F)
	Temperature sensor	NTC10K
	4-ring type	Stainless steel
	Body	ABS
	Connector	DIN, 7 pins
	Dimensions	Total length: 140 mm (5.5") Active part: 95 mm (3.7"); Ø 16.3 mm (0.64")
	Cable	Length 1 m (3.2 ft)
Temperature probe MA831R	Temperature sensor	NTC10K
	Body	Stainless steel
	Connector	RCA
	Dimensions	Total length: 190 mm (7.5") Active part: 120 mm (5.5"); Ø 3,6 mm (1.4")
	Cable	Length 1 m (3.2 ft)

4. FUNCTIONAL & DISPLAY DESCRIPTION

Front Panel

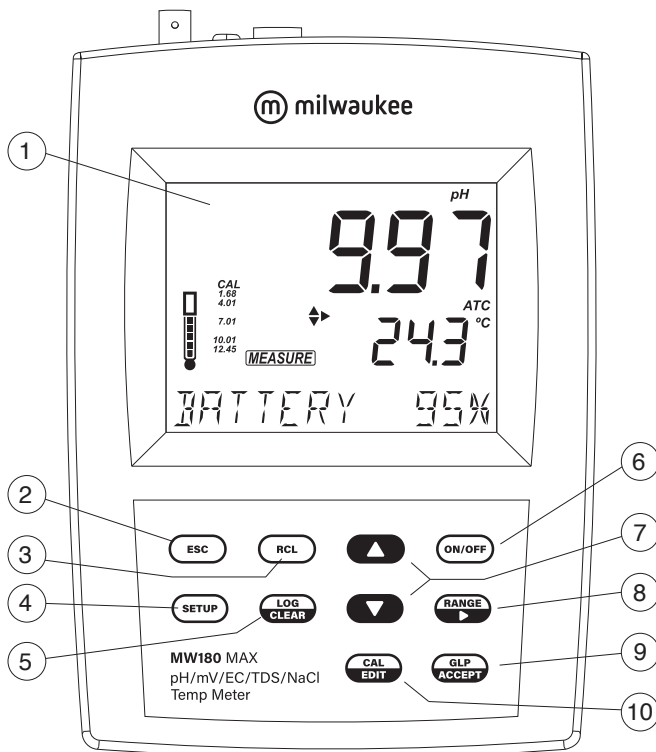

1. Liquid Crystal Display (LCD)
2. ESC key, to exit current mode
3. RCL key, to recall the logged values
4. SETUP key, to enter setup mode
5. LOG/CLEAR key, to log the reading or to clear calibration or logging
6. ON/OFF key
7. ▲▼ directional keys for menu navigation, select setup parameters and calibration solutions
8. RANGE/► key, to select setup parameters and toggle between measurement units
9. GLP/ACCEPT key, to enter GLP or to confirm selected action
10. CAL/EDIT key, to enter/edit calibration settings, edit setup settings

Rear Panel

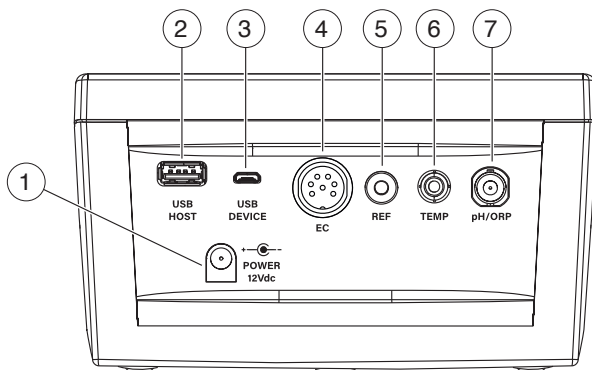

1. Power supply socket
2. USB type A socket
3. Micro USB socket
4. DIN probe connector
5. Reference electrode connector
6. RCA connector for temperature probe
7. BNC electrode connector

Display Description

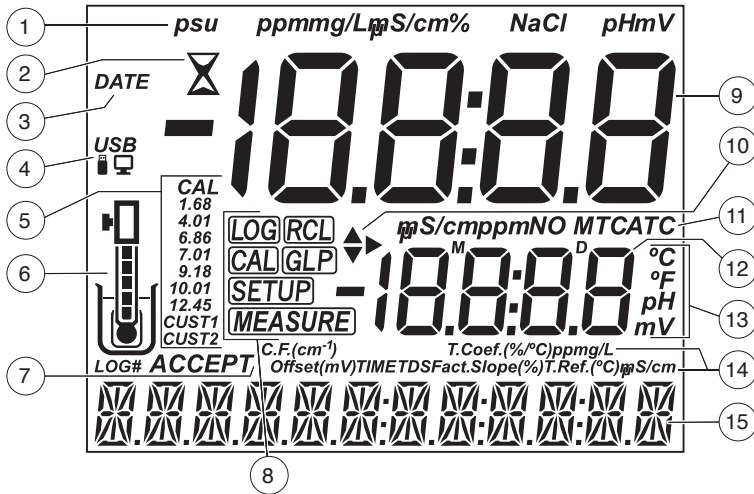

1. Measurement units
2. Stability indicator
3. DATE tag
4. USB connection status
5. pH calibration buffers
6. Probe symbol and probe condition
7. LOG tag and ACCEPT tag
8. Mode tags (LOG, RCL, CAL, GLP, SETUP, MEASURE)
9. First LCD line, measurement reading
10. Arrow tags, to navigate the menu in either direction
11. Measurement units / Temperature compensation status (NO TC, MTC, ATC)
12. Second LCD line, temperature reading
13. Temperature and measurement units
14. Measurement units / offset & slope indicators / TDS settings
15. Third LCD line, message area

5. PROBE DESCRIPTION

MA917B/1 for pH measurement.

- Double junction design, reduces risk of clogging with the reference cell physically separated from the intermediate electrolyte.
- Refillable, with **MA9011** 3.5M KCl. This solution is silver free. Silver can cause silver precipitate to form at the junction resulting in clogging. Clogging causes erratic and slow readings. The ability to refill the electrolyte also extends the life of the electrode.
- Glass body, is easily cleaned and resistant to chemicals.
- Round tip, provides the largest possible surface area for faster readings and is well suited to testing liquid samples.

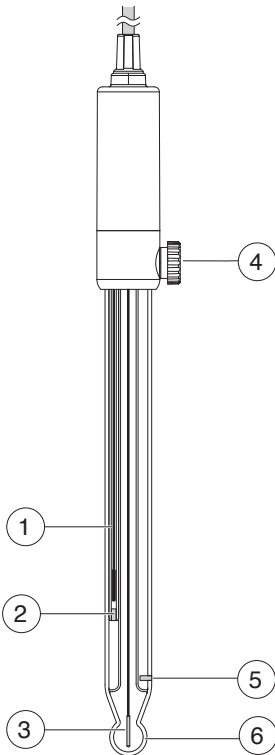

1. Reference wire
2. Inner reference junction
3. Sensing wire
4. Reference fill cap
5. Outer reference junction
6. Glass bulb

MA814DB/1 for conductivity, TDS, salinity and temperature measurement.

- Direct signal processing for noise-free measurements
- Accurate and integrated temperature measurement

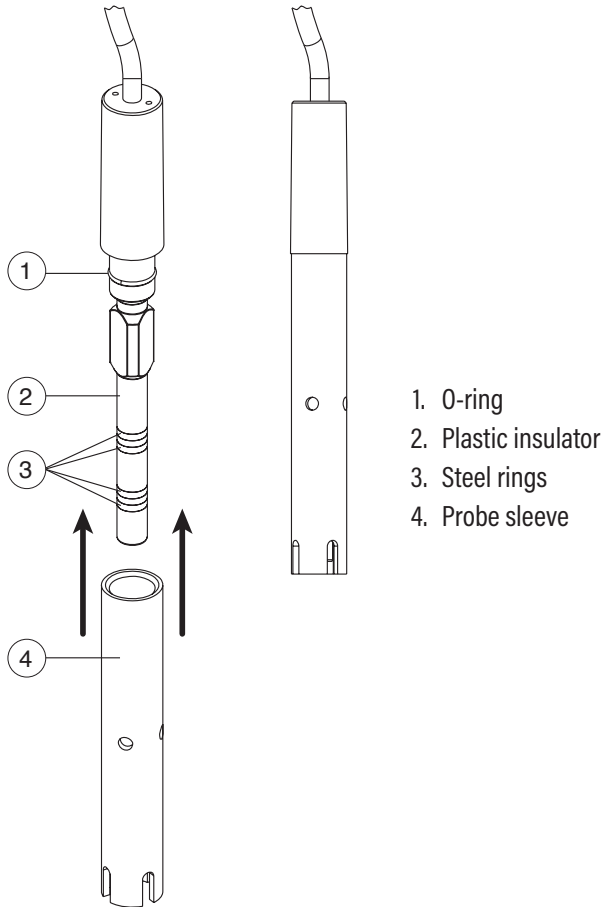

MA831R for temperature measurement and automatic temperature compensation (ATC).

- Made of stainless steel for corrosion resistance
- Used in conjunction with the pH electrode to utilize the instrument's ATC capability

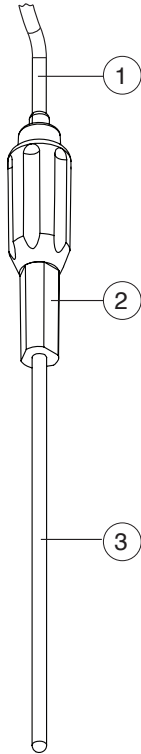

1. Cable
2. Handle
3. Stainless steel tube

6. GENERAL OPERATIONS

6.1. POWER CONNECTION & BATTERY MANAGEMENT

MW180 can be powered from the supplied 12 VDC adapter, through a PC USB port (or standard 5V USB charger) or from the built-in rechargeable battery.

The built-in rechargeable battery provides about 8 hours of continuous use. Fully charge the battery before first use.

To conserve battery, the meter will turn off automatically after 10 minutes of inactivity. To configure this option see Auto Off in GENERAL SETUP OPTIONS section.

At power on the instrument performs an auto-diagnostic test. All LCD segments are displayed for a few seconds, then starts in the previously selected measurement mode.

6.2. MOUNTING THE ELECTRODE HOLDER

- Take the **MA9315** electrode holder from the box.
- Identify the metal plate (4) with the integrated pin (5) and the screw (2).
The plate may be attached to either sides of the meter, left (L) or right (R).
- Turn the meter over, with the display facing down.

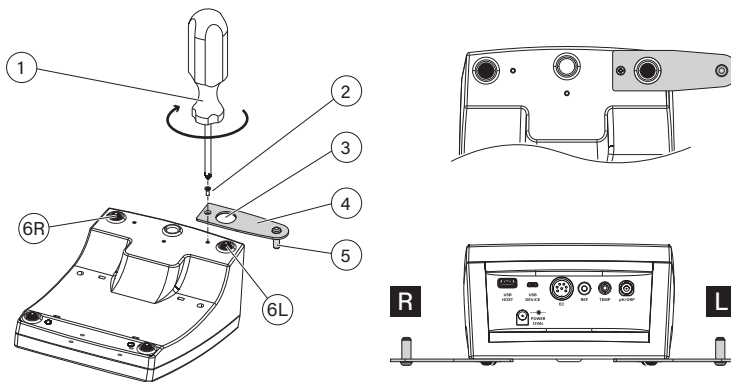

- Align the rubber foot (6R or 6L) with the hole (3) on the plate (4). Make sure the pin (5) is facing down.
- Use a screwdriver (1) to tighten the screw (2) and lock in place.

- Position the meter with the display facing up.
- Take the electrode holder (7) and insert it into the pin (5). The pin securely holds the electrode holder in place.
- For increased arm rigidity, tighten the metal knobs (8) on both sides.

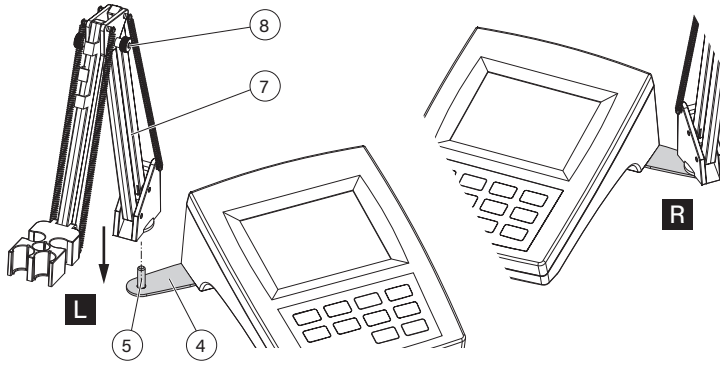

6.3. CONNECTING THE PROBES

6.3.1. MA917B/1 pH Probe

MA917B/1 is connected to the meter through a BNC connector (labeled pH/ORP).

With the meter off:

- Connect the probe to the BNC socket on the top right of the meter.
- Align and twist the plug into the socket.
- Place the probe into the holder and secure the cable in clips.

6.3.2. MA814DB/1 EC/TDS/NaCl Probe

MA814DB/1 is connected to the meter through a DIN connector

With the meter off:

- With the meter off, connect the probe to the DIN socket on the top of the meter.
- Align the pins and key then push the plug into the socket.
- Place the probe into the holder and secure the cable in clips.

6.3.3. MA831R Temperature Probe

MA831R is connected to the meter through a RCA connector (labeled Temp.)

With the meter off:

- Connect the probe to the RCA socket on the top right of the meter.
- Push the plug into the socket.
- Place the probe into the holder and secure the cable in clips.

6.4. ELECTRODE CARE & MAINTENANCE

6.4.1. MA917B/1 pH PROBE

Calibrating & Conditioning

Maintaining a pH electrode is critical to ensure proper and reliable measurements. Frequent 2- or 3-point calibrations are recommended to ensure accurate and repeatable results.

Prior to using the electrode for the first time

1. Remove the protective cap. Do not be alarmed if salts deposits are present, this is normal. Rinse the electrode with distilled or deionized water.
2. Place the electrode in a beaker containing **MA9016** Cleaning solution for a minimum of 30 minutes.

Note: *Do not condition a pH electrode in distilled or deionized water as this will damage the glass membrane.*

3. For refillable electrodes, if the refill solution (electrolyte) has dropped more than 2½ cm (1") below the fill hole, add the appropriate electrolyte solution.
4. After conditioning, rinse the sensor with distilled or deionized water.

Note: *To ensure quick response and avoid cross-contamination, rinse the electrode tip with the solution to be tested before measurement.*

Best practice when handling an electrode

- Electrodes should always be rinsed between samples with distilled or deionized water.
- Do not wipe an electrode as wiping can cause erroneous readings due to static charges.
- Blot the end of the electrode with lint-free paper.

Storage

To minimize clogging and ensure quick response time, the glass bulb and the junction should be kept hydrated.

Add a few drops of **MA9015** Storage solution to the protective cap. Replace the storage cap when the probe is not in use.

Note: *Never store the probe in distilled or deionized water.*

Regular Maintenance

- Inspect the probe. If cracked, replace the probe.
- Inspect the cable. Cable and insulation must be intact.
- Connectors should be clean and dry.
- Rinse off salt deposits with water.
- Follow storage recommendations.

For refillable electrodes:

- Refill the electrode with fresh electrolyte solution (see the electrode's specifications to select the correct refilling solution).
- Keep the electrode upright for 1 hour.
- Follow the storage procedure above.

If electrodes are not maintained correctly both accuracy and precision are affected. This can be observed as a steady decrease in the slope of the electrode.

The slope (%) indicates the sensitivity of the glass membrane, the offset value (mV) indicates the age of electrode and provides an estimation when the probe needs to be changed. The slope percentage is referenced to the ideal slope value at 25 °C.







Milwaukee Instruments recommends that the offset does not exceed ± 30 mV and that the slope percentage is between 85-105%.

When the slope value drops below 50 mV per decade (85% slope efficiency) or the offset at the zero point exceeds ± 30 mV, reconditioning may improve performance, but a change of electrode may be necessary to ensure accurate pH measurements.

Electrode Status

MW180 displays electrode status after calibration. See probe icon on the LCD screen.

The assessment remains active for 12 hours and is based on the electrode offset and slope during calibration.

	5 bars	Excellent condition
	4 bars	Very good condition
	3 bars	Good condition
	2 bars	Fair condition
	1 bar	Poor condition
	1 bar blinking	Very poor condition
	no bar	Not calibrated

Recommendations:

- **1 bar:** Clean the electrode and recalibrate. If there is still only 1 bar or 1 bar blinking after recalibration, replace the probe.
- **No bar:** Instrument was not calibrated on current day or a one-point calibration was performed with previous calibration not yet deleted.

6.4.2. MA814DB/1 EC/TDS/NaCl Probe

When using a new probe, remove the sleeve and inspect the probe prior to use.

Calibrating

Calibration is the first step in obtaining accurate and repeatable results. See CALIBRATION section for details.

Best practice

- Always use fresh standards. The calibration standards are easily contaminated.
- Do not reuse standards.
- Do not use expired standards.

Regular Maintenance

- Inspect the probe for cracks or other damage. Replace the probe if necessary.
- Inspect sensor o-ring for nicks or other damage.
- Inspect the cable. Cable and insulation must be intact.
- Connectors should be clean and dry.
- Follow storage recommendation.

Cleaning Procedure

If a more thorough cleaning is required, remove the sleeve and clean the probe with a cloth and a nonabrasive detergent. Reinsert the sleeve and recalibrate the probe.

Storage

EC probes should always be stored clean and dry.



7. SETUP

7.1. MEASUREMENT MODES

MW180 can switch between measurement modes from the measurement screen. Available options for setup, calibration and measurement will depend on selected mode.

- Press RANGE/▶ from the measurement screen
- Select PH or ORP to enter pH mode

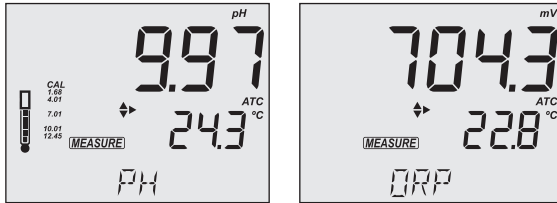

- Select CONDUCTIVITY, TDS, SALINITY to enter EC mode

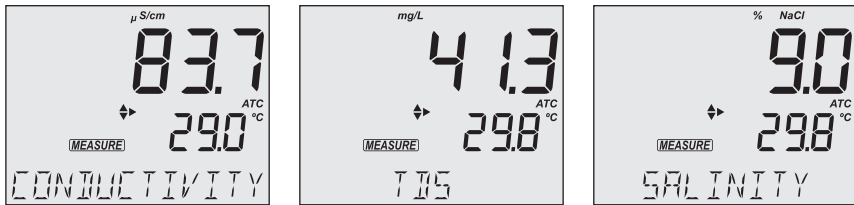

Measurement Mode	Setup Mode	Measurements
PH	pH	pH
ORP		mV
CONDUCTIVITY	EC	EC
TDS		TDS
SALINITY		%NaCl

To configure the meter settings, modify default values or set measurement parameters:

- Press RANGE/▶ to select a measurement mode
- Press SETUP to enter (or exit) Setup mode
- Use ▲▼ keys to navigate the menus (view parameters)
- Press CAL/EDIT to enter Edit mode (modify parameters)
- Press RANGE/▶ key to select between options
- Use ▲▼ keys to modify values (value being modified is displayed blinking)
- Press GLP/ACCEPT to confirm and save changes (ACCEPT tag is displayed blinking)
- Press ESC (or CAL/EDIT again) to exit Edit mode without saving (return to menu)

7.2. GENERAL SETUP OPTIONS

Options available from any measurement mode, with or without a probe connected.

Log Type

Options: INTERVAL (default), MANUAL or STABILITY

Press RANGE/▶ to select between options.

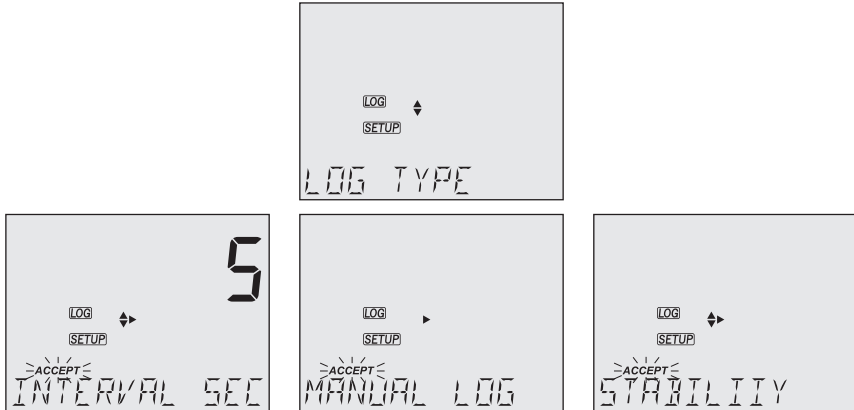

Use ▲▼ keys to set time interval: 5 (default), 10, 30 sec. or 1, 2, 5, 15, 30, 60, 120, 180 min.

Use ▲▼ keys to select stability type: fast (default), medium or accurate.

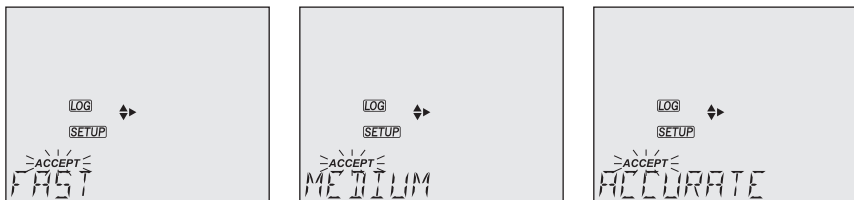

Calibration Expired Warning

Options: 1 to 7 days (default) or off

Use ▲▼ keys to select the number of days since last calibration has elapsed.

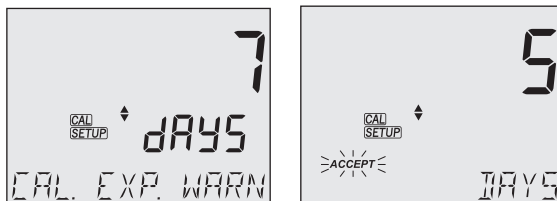

Date

Options: year, month or day

Press RANGE/▶ to select options. Use ▲▼ keys to modify the values.

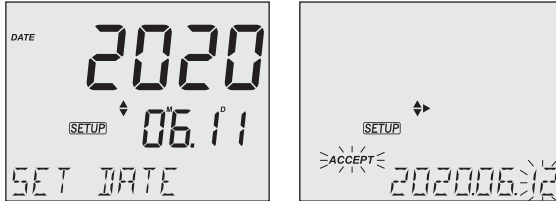

Time

Options: hour, minute or second

Press RANGE/▶ to select. Use ▲▼ keys to modify the values.

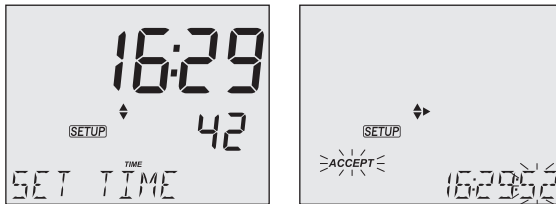

Auto Off

Options: 5, 10 (default), 30, 60 minutes or off

Use ▲▼ keys to select the time.

The meter will power off after set period of time.

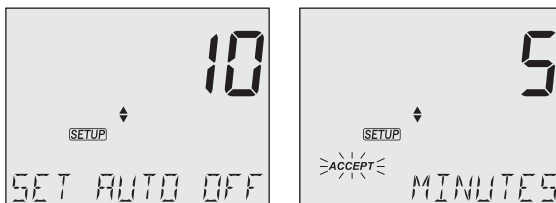

Sound

Options: enable (default) or disable

Use ▲▼ keys to select.

When pressed, each key will emit a short acoustic signal.

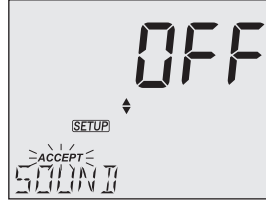
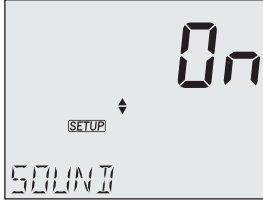

Temperature Unit

Options: °C (default) or °F

Use ▲▼ keys to select the unit.

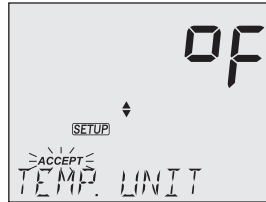
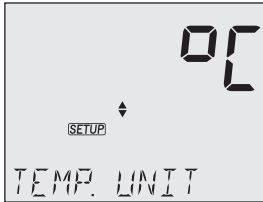

LCD Contrast

Options: 1 to 9 (default)

Use ▲▼ keys to select LCD contrast values.

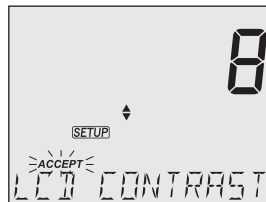
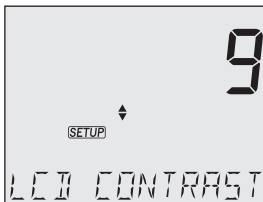

Default Values

Resets meter settings to factory defaults.

Press GLP/ACCEPT to restore the default values. "RESET DONE" message confirms that the meter performs with default settings.

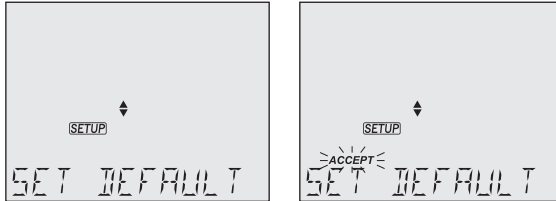

Instrument Firmware Version

Displays the installed firmware version.



Meter ID / Serial Number

Use ▲▼ keys to assign a meter ID from 0000 to 9999.

Press RANGE/▶ to view the serial number.

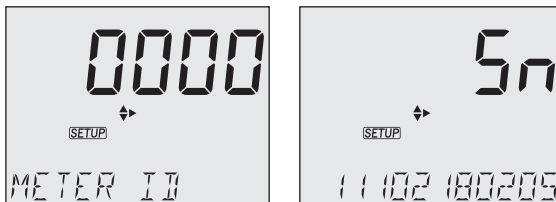

Separator Type

Options: comma (default) or semicolon

Use ▲▼ keys to select the columns separator for the CSV file.

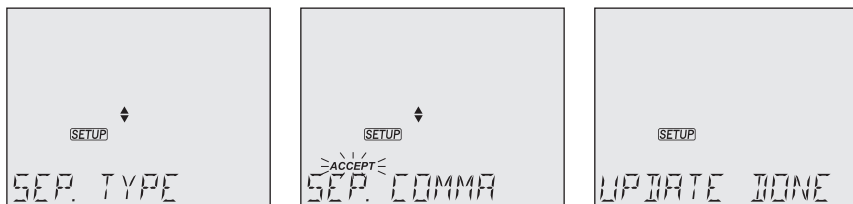

Export to PC / Log on Meter

Options: Export to PC and Log on Meter

With the micro USB cable connected, press SETUP. Press CAL/EDIT to enter Edit mode.

Use ▲▼ keys to select.

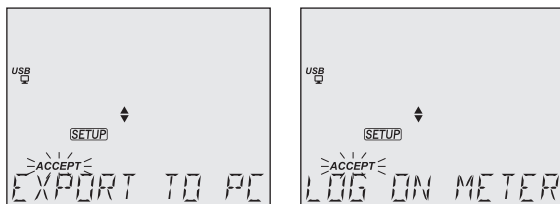

Note: This option is only available while connected to a PC. The USB/PC icon is not displayed if LOG ON METER option was previously set.

7.3. pH MODE SETUP OPTIONS

- With the pH/ORP probe connected press RANGE/▶ on the measurement screen to select PH or ORP to enter pH mode.

pH Information

Options: On (default) or Off (disabled)

Use ▲▼ keys to select.

Displays pH buffer calibration information. When enabled, the electrode symbol displays the electrode condition.

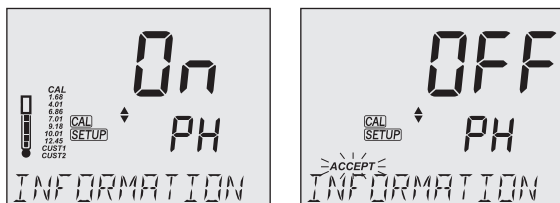

First Custom Buffer

Press RANGE/▶ to set a default buffer value as starting value.

Use ▲▼ keys to set the value of the first custom buffer.

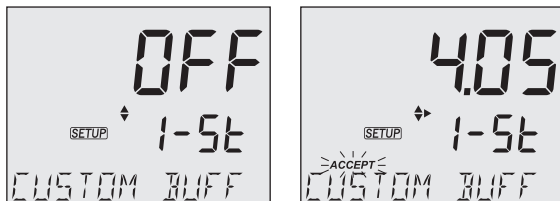

Second Custom Buffer

Press RANGE/▶ to set a default buffer value as starting value.

Use ▲▼ keys to set the value of the second custom buffer.

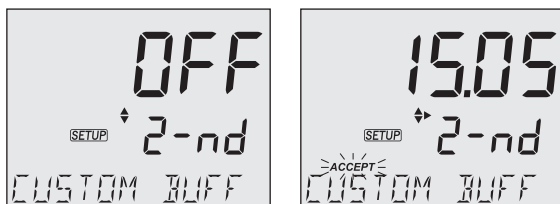

pH Resolution

Options: 0.01 (default) and 0.001

Use ▲▼ keys to select.

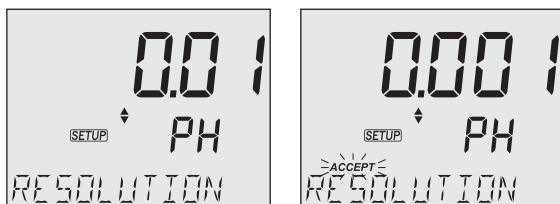

Out of Calibration Range

Options: On (default) or Off (disabled)

Use ▲▼ keys to select.

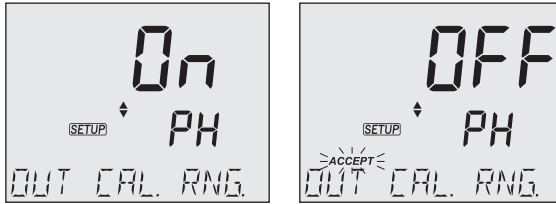

74. EC MODE SETUP OPTIONS

- EC/TDS/NaCl/Temperature probe connected press RANGE/▶ on the measurement screen to select CONDUCTIVITY, TDS, SALINITY to enter EC mode.

Temperature Compensation

Options: ATC (default), MTC or NO TC

Press RANGE/▶ to select options.

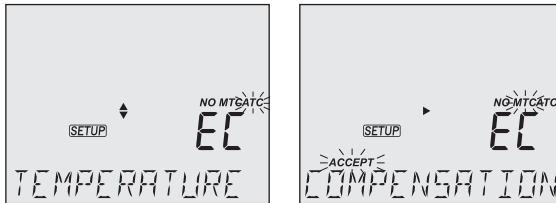

EC Cell Factor

Options: 0.010 (default) to 9.999

With the probe connected, use ▲▼ keys to change the value.

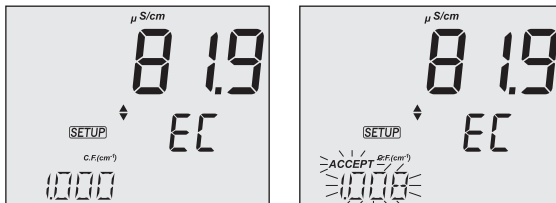

Note: Setting the EC cell-factor value directly will erase any previous calibrations. Log files and GLP will display "MANUAL" as standard.

EC Temperature Coefficient (T.Coef.)

Options: 0.00 to 6.00 (1.90 default)

With the probe connected, use ▲▼ keys to change the value.

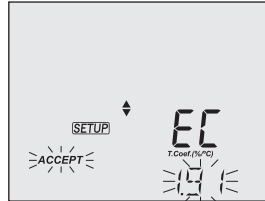
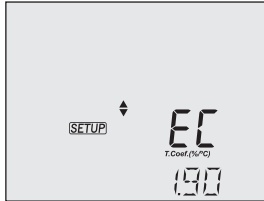

EC Temperature Reference (T.Ref.)

Options: 25 °C (default) and 20 °C

With the probe connected, use ▲▼ keys to change the value.

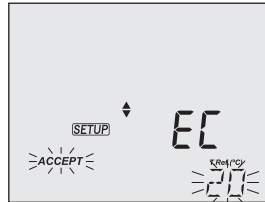
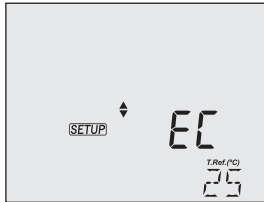

TDS Factor

Options: 0.40 to 0.80 (0.50 default)

With the probe connected, use ▲▼ keys to change the value.

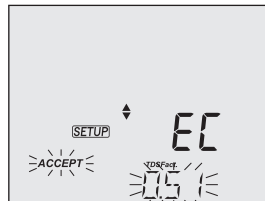
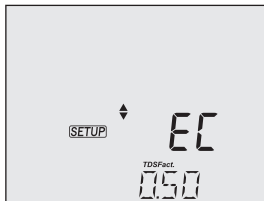

EC Temperature Coefficient / Reference View

Options: T.Coef.(%/°C) or T.Ref.(°C) (default)

With the probe connected, use ▲▼ keys to change between Temperature Coefficient and Temperature Reference.



EC Range

Options: AUTO (default), 29.99 $\mu\text{S/cm}$, 299.9 $\mu\text{S/cm}$, 2999 $\mu\text{S/cm}$, 29.99 mS/cm , 200.0 mS/cm

Note: Absolute conductivity – up to 500.0 mS/cm – is the conductivity value without temperature compensation.

With the probe connected, use ▲▼ keys to change the value.

When autoranging, the meter automatically chooses the optimum conductivity range to maintain the highest possible accuracy.



Note: Selected EC range is active during measurements only. If exceeded, the full-scale value is displayed blinking. Logged data is displayed in $\mu\text{S/cm}$ in the CSV files.

TDS Range

Options: AUTO (default), 14.99 mg/L, 149.9 mg/L, 1499 mg/L, 14.99 g/L, 100.0 g/L

Note: Absolute TDS – up to 400.0 g/L (with 0.8 factor) – is the TDS value without temperature compensation.

With the probe connected, use ▲▼ keys to change the value.

When autoranging, the meter automatically chooses the optimum TDS range to maintain the highest possible accuracy.

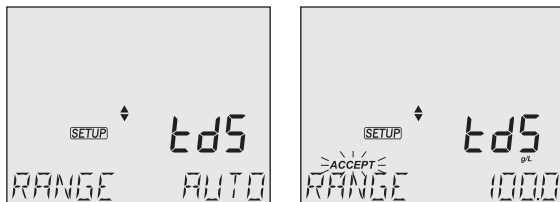

Note: Selected TDS range is active during measurements only. If exceeded, the full-scale value is displayed blinking. Logged data is displayed in mg/L in the CSV files.

TDS Unit

Options: ppm (mg/L) default and g/L

With the probe connected, press RANGE/▶ to select options.

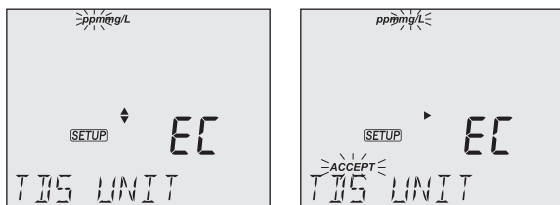

Salinity Scale

Options: NaCl% (default), psu and g/L

With the probe connected, press RANGE/▶ to select options.

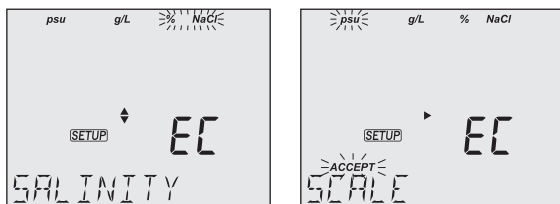

8. pH

Press RANGE/▶ from the measurement screen and select PH.

8.1. PREPARATION

Up to 5-point calibration with a choice of 7 standard buffers and, additionally, calibration with custom buffers (CUST1 and CUST2).

1. Prepare two clean beakers. One beaker is for rinsing and one for calibration.
2. Pour small quantities of the selected buffer solution into each beaker.
3. Remove the protective cap and rinse the probe with the buffer solution for the first calibration point.

If necessary, use the RANGE/▶ key until the display changes to pH range.

8.2. CALIBRATION

General Guidelines

For better accuracy, frequent calibrations are recommended.

The probe should be recalibrated at least once a week, or:

- Whenever is replaced
- After testing aggressive samples
- When high accuracy is required
- When the calibration time out has expired

Procedure

1. Place the pH probe tip approximately 4 cm (1½") into the buffer solution and stir gently. For calibration, use the pH 7.01 (pH 6.86 for NIST) buffer first. Press CAL/EDIT to enter Calibration mode. Buffer value and "WAIT" message are displayed blinking. If required, use the ▲▼ keys to select a different buffer value.

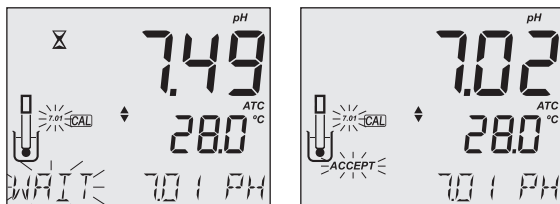

2. When the reading is stable and close to the selected buffer, the ACCEPT tag is displayed blinking. Press GLP/ACCEPT to confirm calibration.

3. After the first calibration point has been confirmed, the calibrated value is displayed on the first LCD line and the second expected buffer value on the third LCD line (i.e. pH 4.01). The value of the first buffer is set while the second expected buffer value is displayed blinking on the screen.

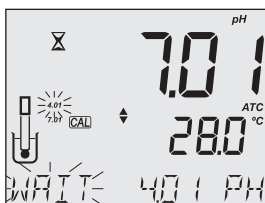

For one-point calibration, press CAL/EDIT to exit calibration. The meter stores the calibration and returns to Measurement mode.

To continue calibrating with additional buffers, rinse and place the pH probe tip approximately 4 cm (1½") into the second buffer solution and stir gently.

If needed, use the ▲▼ keys to select a different buffer value.

Note: When attempting to calibrate with a different buffer (not yet used), the previously used buffers are displayed blinking.

Follow the same steps for 2- or 3-point calibration.

Calibration procedure can be continued up to 5-point following the same steps.

Press CAL/EDIT to exit calibration. The meter stores the calibration and returns to Measurement mode.

For improved accuracy, a minimum of 2-point calibration is recommended.

Note: When performing a new calibration (or adding to an existing calibration) the first calibration point is treated as an offset. Press CAL/EDIT after the first or second calibration point has been confirmed, and the instrument stores the calibration data and returns to Measurement mode.

Custom Buffers

This feature has to be enabled in Setup. Temperature compensation of custom buffers is set to the value of 25°C.

Calibrating with custom buffers:

- Press RANGE/▶. The custom buffer value is blinking on the third LCD line.
- Use the ▲▼ keys to modify the value based on the temperature reading. The buffer value is updated after 5 sec.

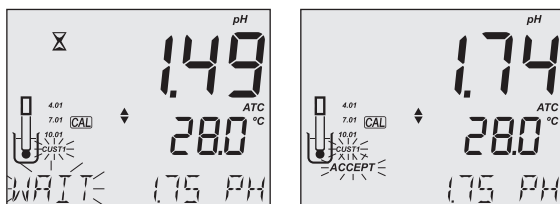

Note: When using custom buffers, CUST1 and CUST2 tags are displayed. If only one custom buffer is used, CUST1 is displayed together with its value.

Expired Calibration

The instrument has a real time clock (RTC) to monitor the time elapsed since the last pH calibration.

The RTC is reset every time the instrument is calibrated and the “expired calibration” status is triggered when the meter detects calibration time out. The “CAL EXPIRED” warns the user that the instrument should be recalibrated.

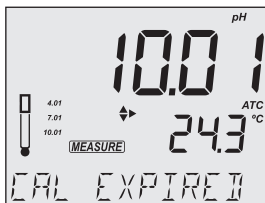

If the instrument is not calibrated or calibration has been deleted, the “NO CAL” message is displayed.

Calibration time-out function can be set from 1 to 7 days (default) or off. See Setup section Calibration Expired Warning for details.

For example, if the warning has been set to 4 days, the instrument will issue the alarm 4 days after the last calibration.

Clear Calibration

1. Press CAL/EDIT to enter Calibration mode.
2. Press LOG/CLEAR (MEM/CLEAR).
ACCEPT tag is displayed blinking and "CLEAR CAL" message is displayed.
3. Press GLP/ACCEPT to confirm.
"PLEASE WAIT" message is displayed followed by the "NO CAL" confirmation screen.

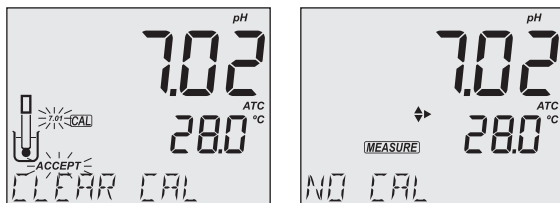

8.3. MEASUREMENT

Remove the probe protective cap and place the tip approximately 4 cm (1 1/2") into the sample. It is recommended to wait for the sample and the pH probe to reach the same temperature.

If necessary, press the RANGE/▶ until the display changes to the pH mode. Allow the reading to stabilize (⊗ stability tag to turn off).

The LCD will display:

- Measurement and temperature readings
- Temperature compensation mode (MTC or ATC)
- Buffers used (if option enabled in Setup)
- Electrode condition (if option enabled in Setup)
- The third LCD line displays: mV offset & slope values, time and date of measurement, battery status. Use the ▲▼ keys to scroll between them.

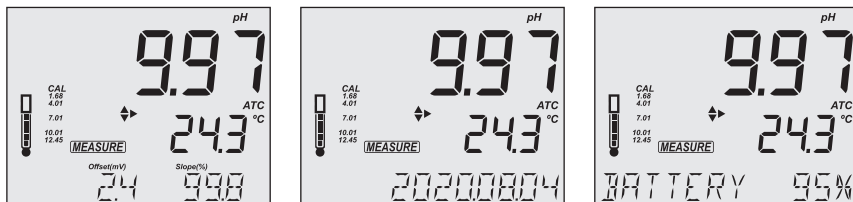

For best results is recommended to:

- Calibrate the probe before use and recalibrate periodically
- Keep the electrode hydrated
- Rinse the probe with the sample before use
- Soak in **MA9015** Storage solution for at least 1 hour before measurement

MTC mode

When the probe is not connected the “NO T. PROBE” message is displayed. The MTC tag and the default temperature (25 °C) with blinking temperature unit are displayed.

1. Press CAL/EDIT and use the ▲▼ keys to set the temperature value manually.
2. Press GLP/ACCEPT to confirm or press ESC (or CAL/EDIT again) to exit without saving.

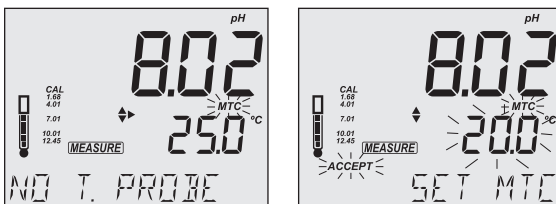

Note: The temperature value used for MTC can be set only when “NO T. PROBE” message is displayed.

8.4. WARNINGS & MESSAGES

The Calibration Check feature flags diagnostic messages during a calibration. As electrode aging is usually a slow process, differences between previous calibrations are likely due to a temporary problem with the probe or buffers.

Messages displayed during calibration

- “WRONG BUFFER” message is displayed blinking when the difference between the pH reading and selected buffer value is significant. Check if correct calibration buffer has been used.

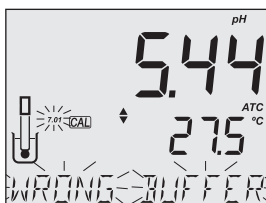

- "WRONG OLD POINTS INCONSISTENT" is displayed if there is discrepancy between new calibration value and old value recorded when calibrating with the same probe in a buffer of the same value. Clear the previous calibration and calibrate with fresh buffers. See Clear Calibration section for details.

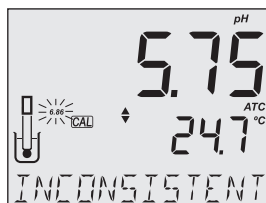
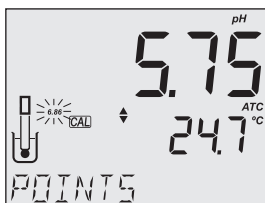
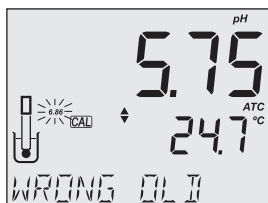

- "CLEAN ELEC" indicates poor electrode performance (the offset is out of the accepted window, or the slope is under the accepted lower limit). Clean the probe to improve response time. See pH Electrode Conditioning and Maintenance for details. Repeat calibration after cleaning.

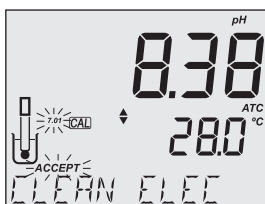

- "CHECK PROBE CHECK BUFFER" is displayed when the electrode's slope exceeds the highest accepted slope limit. Inspect the electrode and make sure the buffer solution is fresh. Clean the probe to improve response time.

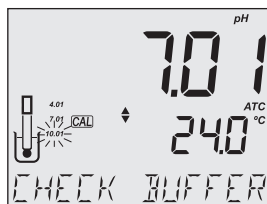
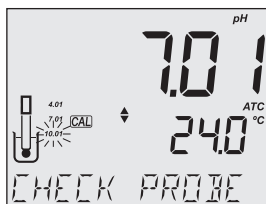

- "BAD ELEC" is displayed when after cleaning, the electrode's performance has not improved. Replace the probe.

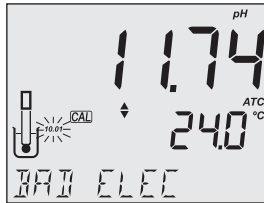

- "WRONG STANDARD TEMPERATURE" is displayed when buffer temperature is out of range. The calibration buffers are affected by temperature changes. During calibration, the instrument will automatically calibrate to the pH value corresponding to the measured temperature but compensate it to the value of 25 °C.

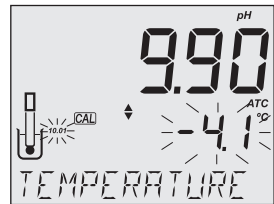
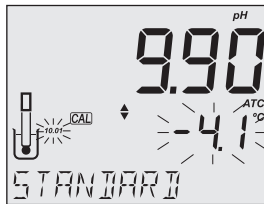
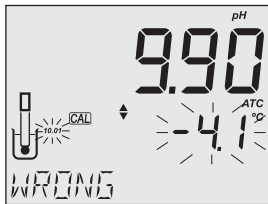

- When "CONTAMINATED BUFFER" is displayed, replace the buffer with a new one and continue the calibration.

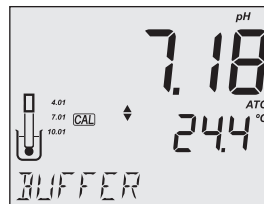
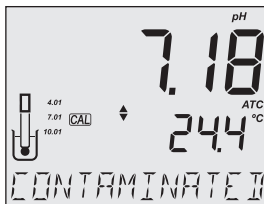

- "VALUE USED BY CUST 1" or "VALUE USED BY CUST 2" message is displayed when attempting to set a custom buffer of the same value as the one previously set. Make sure that set custom buffers have different values.

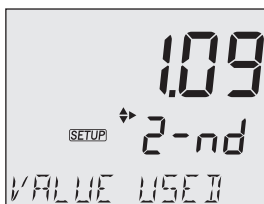

Messages Displayed During Measurement

- "OUT CAL RNG" is displayed when the measured value is outside calibration range. The option has to be enabled (see pH MODE SETUP OPTIONS, Out of Calibration Range section).

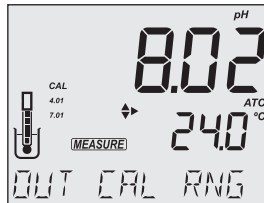

- "OUT OF SPEC" message is displayed when measured parameter and / or temperature are out of range.

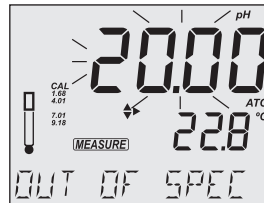
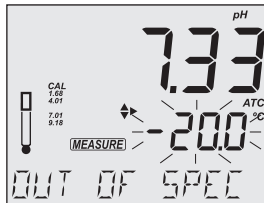

9. ORP

Press RANGE/▶ from the measurement screen and select ORP.

9.1. PREPARATION

For accurate ORP measurements, the surface of the electrode must be clean and smooth. Pretreatment solutions are available to condition the electrode and improve its response time (see ACCESSORIES section).

The ORP range is factory calibrated.

Note: For direct ORP measurements, use an ORP probe. MA9020 ORP Solution can be used to confirm that the ORP sensor measures correctly. mV readings are not temperature compensated.

9.2. MEASUREMENT

1. Press the RANGE/▶ until the display changes to mV mode.
2. Remove the probe protective cap and immerse the tip approximately 4 cm (1½") into the sample. Allow the reading to stabilize (⊗ tag turns off).

The ORP mV reading is displayed on the first LCD line.

The second LCD line displays the temperature of the sample.

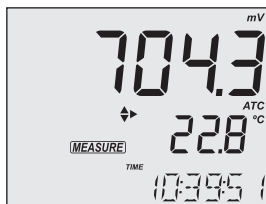

10. EC / TDS

Press RANGE/▶ from the measurement screen and select CONDUCTIVITY.

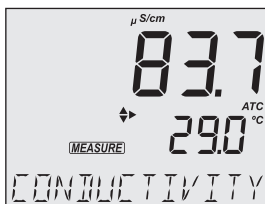

10.1. PREPARATION

Pour sufficient conductivity calibration solution into clean beakers. Ensure that probe's holes are completely submersed. To minimize cross-contamination, use two beakers: one for rinsing the probe and the other for calibration.

Note: A new EC calibration automatically clears the %NaCl calibration . "NO CAL" message is displayed blinking.

10.2. CALIBRATION

General Guidelines

For better accuracy frequent calibration is recommended. The probe should be calibrated:

- Whenever is replaced
- After testing aggressive samples
- When high accuracy is required
- If "NO CAL" is displayed on the third LCD line
- At least once a week

Before performing a calibration:

- Inspect the probe for debris or blockages.
- Always use an EC calibration standard that is close to the sample. Selectable calibration points are 0.00 μS for offset and 84 μS/cm, 1413 μS/cm, 5.00 mS/cm, 12.88 mS/cm, 80.0 mS/cm, 111.8 mS/cm for slope.

To enter EC calibration:

1. Press CAL/EDIT to enter Calibration mode.
2. Use the ▲▼ keys to select a different standard value.

When the reading is stable and close to the selected calibration standard, STD and ACCEPT tags are displayed blinking.

- Press GLP/ACCEPT key to confirm calibration. The instrument displays "SAVING", stores calibration values and returns to measurement mode.

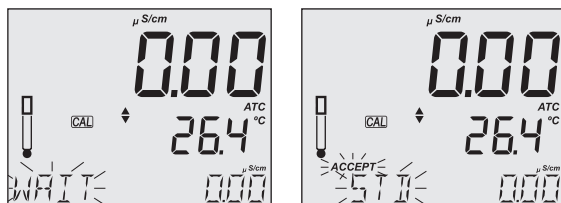

Zero Calibration

For zero calibration, to correct readings around 0.00 $\mu\text{S}/\text{cm}$, keep the dry probe in the air. The slope is evaluated when the calibration is performed in any other point.

One-Point Calibration

- Place the probe in the calibration solution making sure that the sleeve holes are completely submersed. Center the probe away from the bottom or beaker walls.
- Lift and lower the probe to refill the center cavity and tap the probe repeatedly to remove any air bubbles that may have been trapped inside the sleeve.
- Press CAL/EDIT to enter calibration. Use the \blacktriangle / \blacktriangledown keys to select a different standard value. The hourglass symbol and "WAIT" message (blinking) are displayed until the reading is stable.
- When reading is stable and close to the selected calibration standard, SOL STD and ACCEPT tags are displayed blinking.
- Press GLP/ACCEPT key to confirm calibration. The instrument displays "SAVING", stores the calibration values and returns to measurement mode.

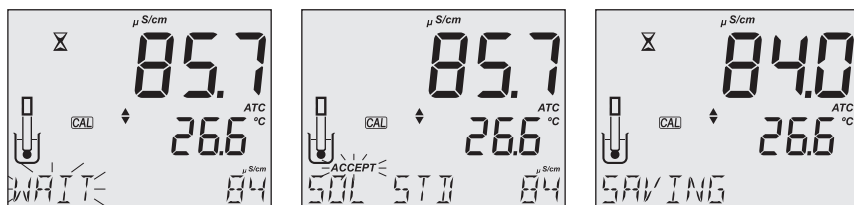

Note: The TDS reading is automatically derived from the EC reading and no calibration is needed.

Manual Calibration

This option may be used to perform a manual calibration in a custom standard, i.e. to set the cell-constant value directly.

To minimize cross-contamination, use two beakers: one for rinsing the probe and the other for calibration.

1. Rinse the probe in the calibration standard. Shake off any excess solution (first beaker).
2. Place the probe in the standard ensuring that the sleeve holes are covered with solution (second beaker).
3. Press SETUP and use the ▲ ▼ keys to select C.F. (cm^{-1}).
4. Press CAL/EDIT.
5. Use the ▲ ▼ keys to modify C.F. (cm^{-1}) until the display reads Custom Standard value.
6. Press GLP/ACCEPT. "MANUAL CALIBRATION CLEARS PREVIOUS CALIBRATIONS" is displayed on the third LCD line. CAL and ACCEPT tags are displayed blinking.
7. Press GLP/ACCEPT to confirm or press ESC to exit without changing.

Note: Using manual calibration will erase previous calibrations; and both log files and GLP will display "MANUAL" as standard.

Clear Calibration

Press CAL/EDIT to enter Calibration mode, then press LOG/CLEAR. ACCEPT tag is displayed blinking and "CLEAR CALIBRATION" message on the third LCD line.

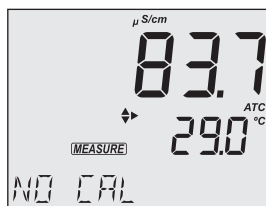
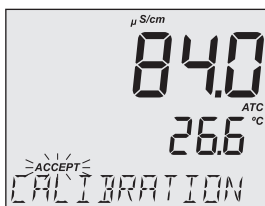
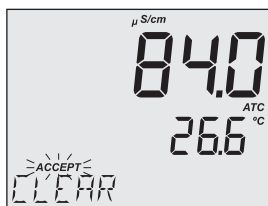

To confirm, press GLP/ACCEPT. "PLEASE WAIT" message is displayed followed by "NO CAL" confirmation screen.

10.3. MEASUREMENT

Conductivity Measurement

When connected, the **MA814DB/1** probe is automatically recognized.

Place the calibrated probe in the sample, making sure that the sleeve holes are completely submerged. Tap the probe to remove any air bubbles that may be trapped inside the sleeve.

The conductivity value is displayed on the first LCD line, the temperature on the second LCD line and calibration or range-specific information on the third LCD line.

To toggle between information displayed on the third LCD line, use the ▲▼ keys.

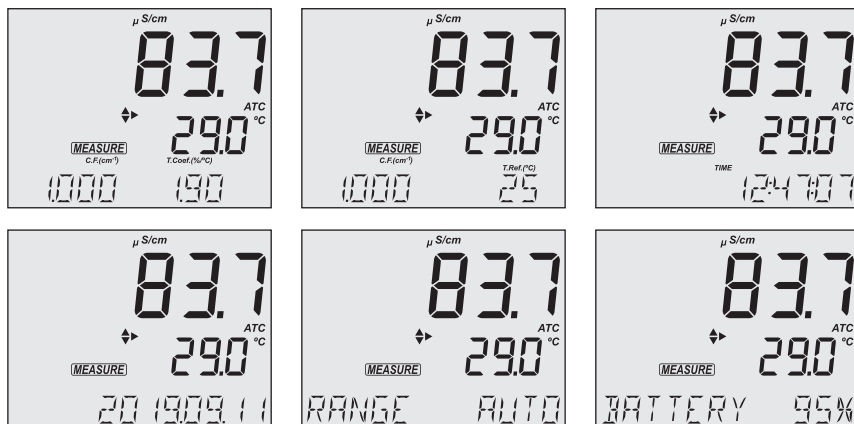

Readings can be temperature compensated.

- **Automatic Temperature Compensation (ATC), default:** The probe has a built-in temperature sensor; the temperature value is used to automatically compensate the EC / TDS reading.

When in ATC mode, ATC tag is displayed and measurements are compensated using the temperature coefficient. Recommended default value for water samples is 1.90% / °C. Temperature compensation is referenced to the selected reference temperature.

Use the ▲▼ keys to view the current temperature coefficient. The value is displayed along with the Cell Factor (C.F.) on the third LCD line.

To change the temperature coefficient, see SETUP section for details.

A temperature coefficient must also be set for the sample.

Note: If the reading outside of range when the range is set to automatic, the full-scale value (200.0 mS/cm for MTC/ATC or 500.0 mS/cm for No TC) is displayed blinking.

- **Manual (MTC):** The temperature value, shown on the second LCD line, can be manually set using the ▲▼ keys. When in MTC mode, the °C tag is displayed blinking.
- **No Temperature Compensation (NO TC):** The temperature value is displayed, but not taken into account. When this option is selected, the NO TC tag is displayed. The reading displayed on the first LCD line is the uncompensated EC or TDS value.

Note: Temperature-compensation and absolute conductivity (NO TC) are configured in Setup.

TDS Measurement

Press RANGE/▶ from the measurement screen and select TDS.

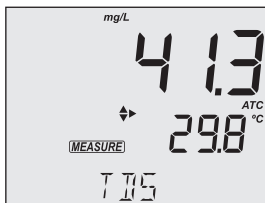

- The TDS reading is displayed on the first LCD line and the temperature reading on the second LCD line.
- Measured value is displayed in the set parameter unit (ppm or mg/L). Values above 1500 ppm (1500 mg/L) are displayed only in g/L unit. See SETUP section for details.
- If the reading is out of range, the full-scale value is displayed blinking.

To toggle between information displayed on the third LCD line, use the ▲▼ keys.

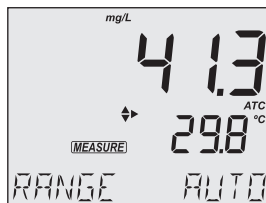
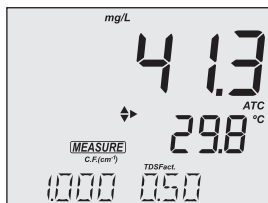

10.4. WARNINGS & MESSAGES

Messages Displayed During Calibration

- If the reading exceeds expected value, "WRONG STANDARD" message is displayed and calibration can not be confirmed. Check that correct calibration solution has been used and / or clean the probe. See PROBE MAINTENANCE section for details.

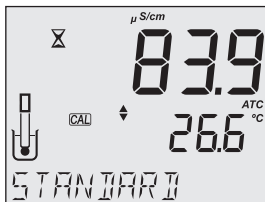
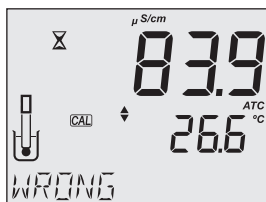

- When using ATC mode, if the temperature of the solution is outside the accepted interval, the "WRONG STANDARD TEMPERATURE" message is displayed. Temperature is displayed blinking.

Messages Displayed During Measurement

- "OUT OF SPEC" message is displayed when measured parameter and / or temperature are out of range.
- "OVER RANGE" message and range value (blinking) is displayed if EC measurement exceeds the user-selected range.

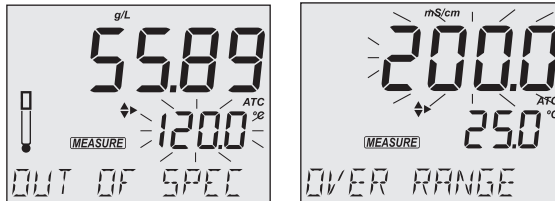

- "NO CAL" message indicates that the probe needs to be calibrated or that the previous calibration has been deleted.
- If the probe is not connected, "NO PROBE" message is displayed.

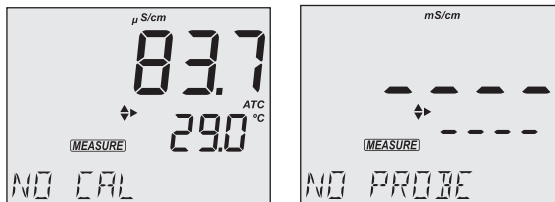

Messages Displayed During Interval Logging

- If EC temperature exceeds the specified limits, "OUT OF SPEC" message is displayed alternatively with the Log specific messages.
- If the probe sensor is disconnected or damaged, logging stops and "NO PROBE" message is displayed on the third LCD line. The log file will indicate "Log end - Probe disconnected".

11. SALINITY

Press RANGE/▶ from the measurement screen and select SALINITY.

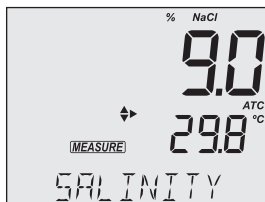

11.1. PREPARATION

Pour small quantities of **MA9066** Salinity calibration solution into clean beakers. To minimize cross-contamination, use two beakers: one for rinsing the probe and the other for calibration.

Note: When the meter is switched on, it starts measuring with the previously selected range (conductivity, TDS or salinity).

11.2. CALIBRATION

Press RANGE/▶ to select the Salinity mode, with %NaCl tag displayed.

%NaCl calibration is a one-point calibration at 100.0% NaCl.

1. Place the probe in the calibration solution making sure that the sleeve holes are completely submersed. Center the probe away from the bottom or beaker walls.
2. Lift and lower the probe to refill the center cavity and tap the probe repeatedly to remove any air bubbles that may have been trapped inside the sleeve.
3. Press CAL/EDIT to enter to calibration mode.
The first LCD line displays the NaCl reading, the second LCD line displays the CAL tag and the third LCD line, the closest calibration point.

The hourglass symbol and "WAIT" message (blinking) are displayed until the reading is stable. When the reading is stable and close to the selected calibration standard, "SOL STD" message and ACCEPT tag are displayed blinking.

4. Press GLP/ACCEPT key to confirm calibration. The instrument displays "SAVING", stores the calibration values and returns to Measurement mode.

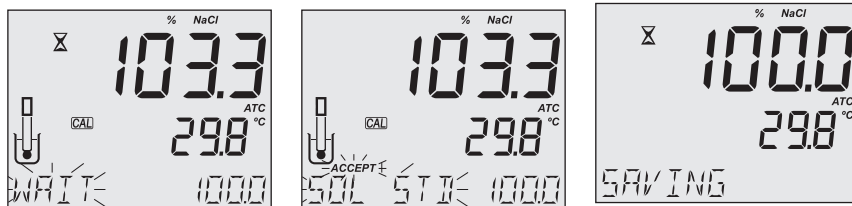

Note: A new EC calibration automatically clears the %NaCl calibration. “NO CAL” message is displayed.

11.3. MEASUREMENT

MW180 supports three seawater salinity scales:

- Practical Salinity Units (PSU)
- Natural seawater (g/L)
- Percentage NaCl (%NaCl)

The required scale is configured in EC MODE SETUP OPTIONS Salinity Scale section.

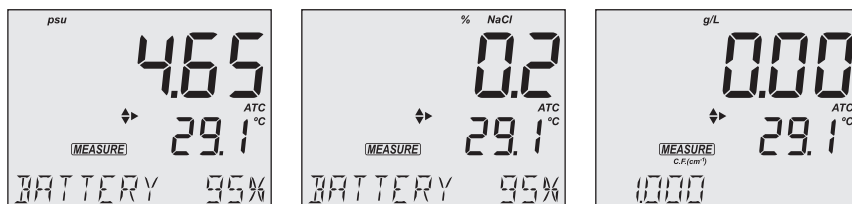

Note: These units are for determining salinity and they refer to general use of saltwater. Practical salinity and natural seawater require a conductivity calibration. NaCl% requires calibration in MA9066 standard.

PSU – Practical Salinity Units

The practical salinity (S) of seawater relates the ratio of electrical conductivity of a seawater sample at 15 °C and 1 atmosphere to a potassium chloride solution (KCl) with a mass of 32.4356 g/Kg water at the same temperature and pressure.

The ratio is equal to 1, and $S=35$.

The practical salinity scale may be applied to values to through 42.00 PSU at temperatures between -2 to 35 °C.

Salinity of a sample in practical salinity units (PSU) is calculated using the following formula:

$$R_T = \frac{C_T(\text{sample})}{C(35,15) \cdot r_T}$$

$$r_t = 1.0031 \cdot 10^{-9} T^4 - 6.9698 \cdot 10^{-7} T^3 + 1.104259 \cdot 10^{-4} T^2 + 2.00564 \cdot 10^{-2} T + 6.766097 \cdot 10^{-1}$$

$$\text{Sal} = \sum_{k=0}^5 a_k \cdot R_T^{\frac{k}{2}} + f(t) \cdot \sum_{k=0}^5 b_k R_T^{\frac{k}{2}} - \frac{c_0}{1 + 1.5X + X^2} - \frac{c_1 f(t)}{1 + Y^{\frac{1}{2}} + Y^{\frac{3}{2}}}$$

$$f(t) = \frac{T - 15}{1 + 0.0162 \cdot (T - 15)}$$

where:

R_T	ratio of sample conductivity to standard conductivity at Temperature (T)
$C_T(\text{sample})$	uncompensated conductivity at T °C
$C(35, 15) = 42.914 \text{ mS/cm}$	the corresponding conductivity of KCl solution containing a mass of 32.4356 g KCl/1 Kg solution
r_T	temperature compensation polynomial

$a_0 = 0.008$	$b_0 = 0.0005$	$c_0 = 0.008$
$a_1 = -0.1692$	$b_1 = -0.0056$	$c_1 = 0.0005$
$a_2 = 25.3851$	$b_2 = -0.0066$	
$a_3 = 14.0941$	$b_3 = -0.0375$	$X = 400R_T$
$a_4 = -7.0261$	$b_4 = 0.0636$	$Y = 100R_T$
$a_5 = 2.7081$	$b_5 = -0.01442$	

%NaCl Percentage

In this scale 100% salinity is equivalent to roughly 10% solids.

If the reading is outside range, the full-scale value (400.0%) is displayed blinking.

High percentages were made by evaporation.

Natural Sea Water

The Natural Sea Water scale extends from 0.00 to 80.00 g/L. It determines salinity based upon a conductivity ratio of sample to "standard seawater" at 15 °C.

$$R_{15} = \frac{C_T(\text{sample})}{C(35, 15) \cdot r_T}$$

where:

R_{15} is the conductivity ratio.

C_T (sample) is uncompensated conductivity at T °C.

$C(35,15) = 42.914$ mS/cm is the corresponding conductivity of KCl solution containing a mass of 32.4356 g KCl/1 Kg solution.

r_T is temperature compensation polynomial.

Salinity is defined by the following equation:

$$S = -0.08996 + 28.2929729R_{15} + 12.80832R_{15}^2 - 10.67869R_{15}^3 + 5.98624R_{15}^4 - 1.32311R_{15}^5$$

Note: The formula can be applied for temperatures between 10 and 31 °C.

11.4. WARNINGS & MESSAGES

Messages Displayed During Calibration

- If an EC calibration is performed, the %NaCl calibration is automatically cleared. A new %NaCl calibration is required.
- If the reading exceeds the expected calibration standard, "WRONG STANDARD" message is displayed and calibration is not confirmed. Check if the correct calibration solution has been used and / or clean the probe. See ELECTRODE CARE & MAINTENANCE section.

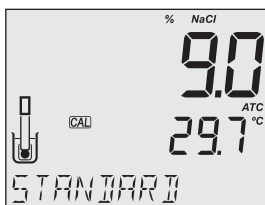
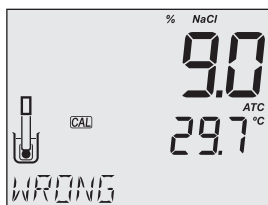

- If the temperature is outside the 0.0 to 60.0 °C range, "WRONG STANDARD TEMPERATURE" message is displayed. Temperature value is displayed blinking.

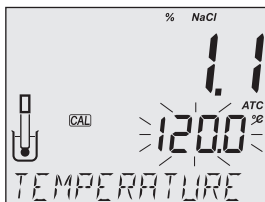

Messages Displayed During Measurement

- "OUT OF SPEC" message is displayed when measured parameter and / or temperature are out of range.

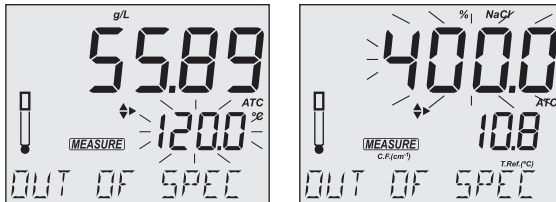

- If a %NaCl calibration is required, "NO CAL" message is displayed.

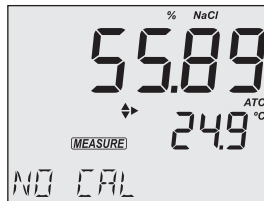

- If Calibration Expired Warning is on and the set number of days has passed, or an EC calibration was performed (clearing the %NaCl calibration), the "CAL EXPIRED" message is displayed.
- If the probe is not connected, "NO PROBE" message is displayed.

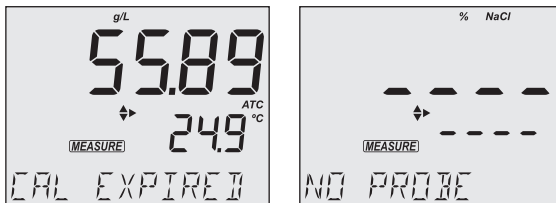

12. LOGGING

MW180 can switch between measurement modes from the measurement screen. Available logging options will depend on selected mode.

- Press RANGE/▶ from the measurement screen
- Select PH or ORP to enter PH mode or CONDUCTIVITY, TDS, SALINITY to enter EC mode.

Measurement Mode	Logging Mode	Measurements
PH	PH	pH
ORP		mV
CONDUCTIVITY	EC	EC
TDS		TDS
SALINITY		%NaCl

- Press LOG/CLEAR to log the current measurement.
- Press RCL to access or export logged data.

Note: Logging locations are measurement mode specific. PH and ORP logs will be saved under "PH", and CONDUCTIVITY, TDS, SALINITY logs under "EC".

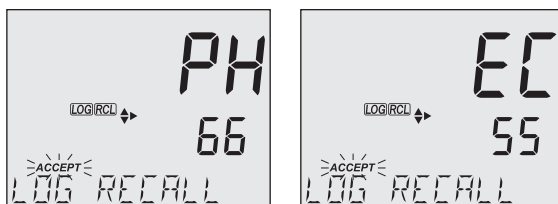

MW180 supports three types of logging: manual log on demand, log on stability and interval logging. See Log Type in GENERAL SETUP OPTIONS section.

The meter can store two independent sets of up to 1000 log records each. Either can contain up to 200 for manual log on demand, up to 200 for log on stability and up to 1000 for interval logging. See DATA MANAGEMENT section.

Note: An interval logging lot can hold up to 600 records. When an interval logging session exceeds 600 records, another log file is automatically generated.

12.1. TYPES OF LOGGING

Manual log on demand

- Readings are logged each time LOG/CLEAR is pressed
- All manual readings are stored in a single lot (i.e. records made on different days share the same lot)

Log on stability

- Readings are logged each time LOG/CLEAR is pressed and stability criteria is reached
- Stability criteria can be set to fast, medium or accurate
- All stability readings are stored in a single lot (i.e. records made on different days are logged in the same lot)

Interval logging

- Readings are logged continuously at a set time interval (e.g. every 5 or 10 minutes).
- Records are added to it until the session stops.
- For each interval logging session, a new lot is created.

A complete set of GLP information including date, time, range selection, temperature reading and calibration information is stored with each log.

Manual Log on Demand

1. From the Setup mode, set Log Type to MANUAL.
2. From the measurement screen press LOG/CLEAR.
LCD displays "PLEASE WAIT". The LOG ### "SAVED" screen displays stored log number.
"FREE" ### screen displays the number of available records.
Meter then returns to measurement screen.

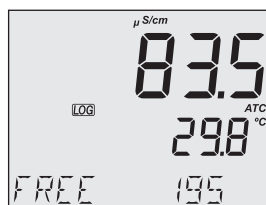
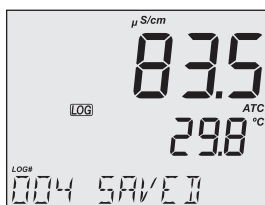
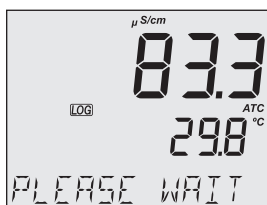

Log on Stability

1. From the Setup mode, set Log Type to STABILITY and the desired stability criteria.
2. From the measurement screen press LOG/CLEAR.
LCD displays "PLEASE WAIT" then "WAITING", until stability criteria is reached.

Note: Pressing ESC or LOG/CLEAR with "WAITING" displayed, exits without logging.

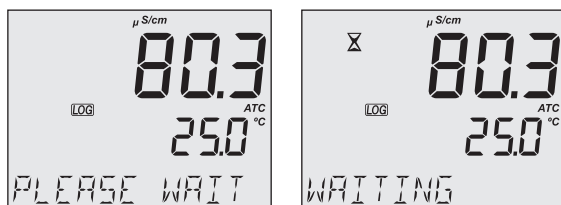

The LOG ### "SAVED" screen displays stored log number. "FREE" ### screen displays total number of available records. Meter then returns to measurement screen.

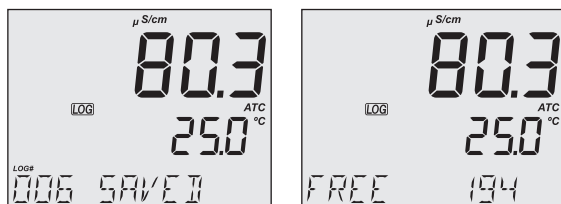

Interval Logging

1. From the Setup mode, set Log Type to INTERVAL (default) and desired time interval.
2. From the measurement screen press LOG/CLEAR. LCD displays "PLEASE WAIT". The LOG ### LOT ### screen displays on third LCD line the measurement log number (bottom left) and interval logging session lot number (bottom right).

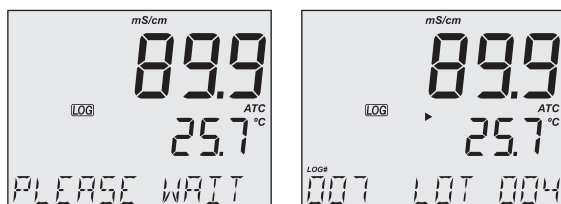

3. Press RANGE/▶ during logging to display the number of available records ("FREE" ###). Press RANGE/▶ again to return to return to active logging screen.

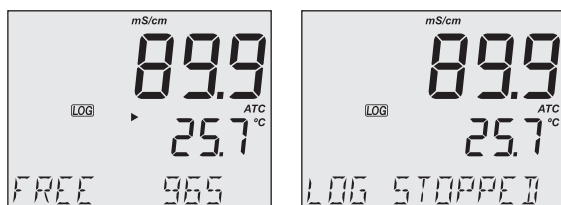

4. Press LOG/CLEAR again (or ESC) to end current interval logging session. LCD displays "LOG STOPPED". Meter returns to measurement screen.

Interval Logging Warnings

"OUT OF SPEC"	Sensor failure is detected. Loggings stops.
"MAX LOTS"	Maximum number of lots reached (100). Cannot create new lots.
"LOG FULL"	Log space is full (1000 logs limit was reached). Loggings stops.

12.2. DATA MANAGEMENT

Each logging storage location ("PH" or "EC") is independent and organized in lots.

- A lot contains 1 to 600 log records (saved measurement data points)
- Maximum number of lots that can be stored is 100, excluding Manual and Stability
- Maximum number of log records that can be stored is 1000, across all lots
- Manual and Stability logs can store up to 200 records (each)
- Interval logging sessions (across all 100 lots) can store up to 1000 records. When a logging session exceeds 600 records a new lot will be created.
- Lot name is given by a number, from 001 up to 999. Names are allocated incrementally, even after some lots have been deleted. Once lot name 999 was assigned, all lots have to be deleted, to reset lot naming to 001.

See Deleting Data section.

12.2.1. Viewing data

1. Press RCL to access the logged data.

LCD displays "PLEASE WAIT" followed by "LOG RECALL" with ACCEPT tag blinking and the number of stored logs.

2. Use ▲▼ keys to select between log storage locations "PH" or "EC".

Note: Press RANGE/▶ to export all logs from the selected location to external storage.

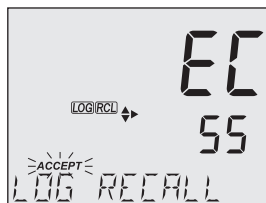
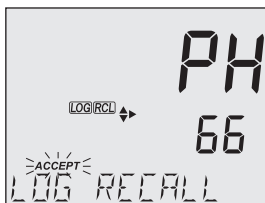
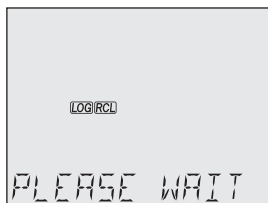

3. Press GLP/ACCEPT to confirm.
4. Use ▲▼ keys to select the lot type (MANUAL, STABILITY or INTERVAL ###).

Note: Press RANGE/▶ to export only the selected lot to external storage.

5. Press GLP/ACCEPT to confirm.

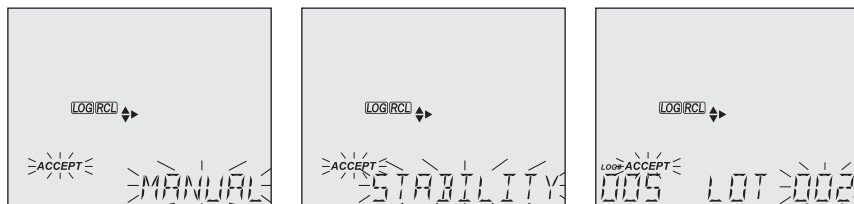

- With a lot selected, use ▲▼ keys to view the records stored in that lot.
- Press RANGE/▶ to view, additional log data: date, time, cell factor, temperature coefficient, temperature reference, displayed on the third LCD line.

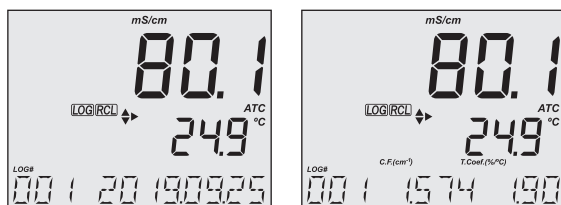

12.2.2. Deleting Data

Manual Log on Demand & Stability Log

- Press RCL to access the logged data.
LCD displays "PLEASE WAIT" followed by "LOG RECALL" with ACCEPT tag blinking and the number of stored logs.
- Use ▲▼ keys to select between log storage locations "PH" or "EC".
- Press GLP/ACCEPT to confirm.
- Use ▲▼ keys to select MANUAL or STABILITY lot type.

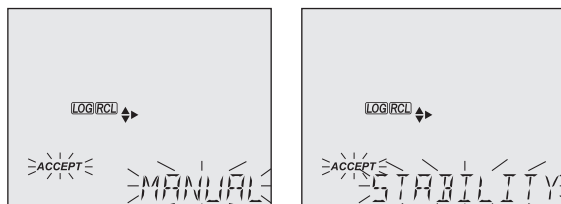

- With a lot selected, press LOG/CLEAR to delete entire lot.
"CLEAR" is displayed with ACCEPT tag and lot name blinking.
- Press GLP/ACCEPT to confirm (to exit, press ESC or CAL/EDIT or LOG/CLEAR).
"PLEASE WAIT" with ACCEPT tag blinking is displayed, until the lot is deleted.
After the selected lot has been deleted, "CLEAR DONE" displays briefly.
Display shows "NO MANUAL / LOGS" or "NO STABILITY / LOGS".



Individual Logs / Records

1. Press RCL to access the logged data.
LCD displays "PLEASE WAIT" followed by "LOG RECALL" with ACCEPT tag blinking and the total number of logs.
2. Use ▲▼ keys to select between log storage locations "PH" or "EC".
3. Press GLP/ACCEPT to confirm.
4. Use ▲▼ keys to select MANUAL or STABILITY lot type.
5. Press GLP/ACCEPT to confirm.
6. Use the ▲▼ to navigate between logs. Log record number displays on the left.
7. With desired log record selected, press LOG/CLEAR to delete.
"DELETE" is displayed with ACCEPT tag and log ### blinking.
8. Press GLP/ACCEPT to confirm (to exit, press ESC or CAL/EDIT or LOG/CLEAR).
"DELETE" and Log ### blinking is displayed, until the log is deleted.
After the log has been deleted "CLEAR DONE" message displays briefly.
Display shows logged data of the next log ###.

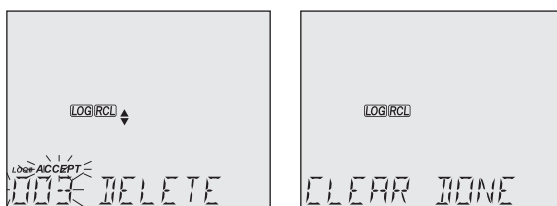

Note: Logs stored within an interval lot can not be deleted individually.

Log on Interval

1. Press RCL to access the logged data.
LCD displays "PLEASE WAIT" followed by "LOG RECALL" with ACCEPT tag blinking and the total number of logs.
2. Use ▲▼ keys to select between log storage locations "PH" or "EC".
3. Press GLP/ACCEPT to confirm.
4. Use ▲▼ keys to select an interval logging lot number.

The LOG ### LOT ### screen displays selected lot number (bottom right) and total logs stored in lot (bottom left).

5. Press GLP/ACCEPT to confirm (to exit, press ESC or CAL/EDIT or LOG/CLEAR).
6. With the lot selected, press LOG/CLEAR to delete entire lot.
"CLEAR" is displayed with ACCEPT tag and lot name blinking.

Note: Use ▲▼ keys to select a different lot number.

7. Press GLP/ACCEPT to confirm (to exit, press ESC or CAL/EDIT or LOG/CLEAR).
"PLEASE WAIT" with ACCEPT tag blinking is displayed, until the lot is deleted.
After the lot has been deleted "CLEAR DONE" message displays briefly.
Display shows the previous lot ###.

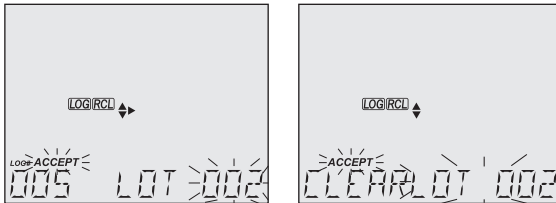

Delete All

1. Press RCL to access the logged data.
LCD displays "PLEASE WAIT" followed by "LOG RECALL PH" or "LOG RECALL EC" with ACCEPT tag and either "PH" or "EC" blinking and the number of stored logs.
2. Use ▲▼ keys to select between log storage locations "PH" or "EC".
3. Press LOG/CLEAR to delete all logs from the selected location.
"CLEAR LOG PH" or "CLEAR LOG EC" is displayed with ACCEPT tag and PH/EC blinking.
4. Press GLP/ACCEPT to confirm (to exit, press ESC or CAL/EDIT; or LOG/CLEAR).
"PLEASE WAIT" is displayed with a percentage counter, until all logs are deleted.
After all logs have been deleted "CLEAR DONE" message displays briefly.
Display returns to the log recall screen.

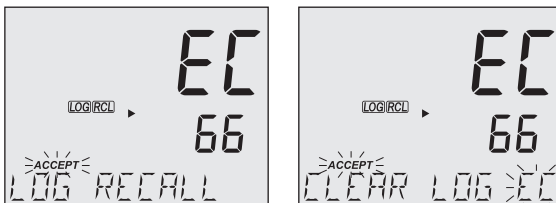

12.2.3. Exporting Data

PC Export

1. With the meter on, use the supplied micro USB cable to connect to a PC.
2. Press SETUP then CAL/EDIT.
3. Use the ▲▼ keys and select "EXPORT TO PC".
The meter is detected as a removable drive. LCD displays the PC icon.
4. Use a file manager to view or copy files on the meter.

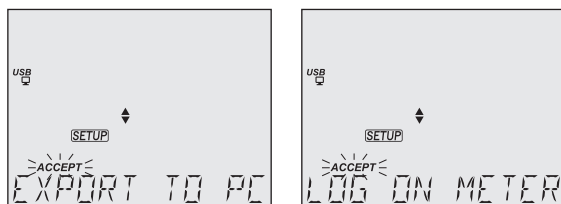

When connected to a PC, to enable logging:

- Press LOG/CLEAR. LCD displays "LOG ON METER" with ACCEPT tag blinking.
- Press GLP/ACCEPT. Meter disconnects from the PC and the PC icon is no longer displayed.
- To return to "EXPORT TO PC" mode, follow steps 2 and 3 above.

Exported data file details:

- The CSV file (comma separated values) may be opened with a text editor or spreadsheet application.
- The CSV file encoding is Western Europe (ISO-8859-1).
- Field separator may be set as comma or semicolon. See Separator Type in GENERAL SETUP OPTIONS section.

Note: File prefix depends on measurement log storage locations: "PHLOT###" for pH or ORP logs and "ECLOT###" for EC, TDS, and Salinity logs.

- Interval log files are named PHLOT### or ECLOT###, where ### is the lot number (e.g. PHLOT051 or ECLOT051).
- Manual log file is named PHLOTMAN / ECLOTMAN and stability log file is named PHLOTSTA / ECLOTSTA.

USB Export All

1. With the meter on, insert a USB flash drive into the USB type A socket.
2. Press RCL then use ▲▼ keys to select between log storage locations "PH" or "EC".
3. Press RANGE/▶ to export all logs from the selected location to external storage.

4. Press GLP/ACCEPT to confirm.

LCD displays "EXPORTING" and the percentage counter, followed by "DONE" when export is completed. Display returns to the lot selection screen.

Note: The USB flash drive can be safely removed if the USB icon is not displayed. Do not remove the USB drive during export.



Overwriting existing data:

1. When the LCD displays "OVR" with LOT### blinking (USB icon is displayed), an identical named lot exists on the USB.
2. Press ▲▼ keys to select between YES, NO, YES ALL, NO ALL (ACCEPT tag blinking).
3. Press GLP/ACCEPT to confirm. Not confirming exits the export. Display returns to lot selection screen.

USB Export Selected

Logged data can be transferred separately by lots.

1. Press RCL to access the logged data.
LCD displays "PLEASE WAIT" followed by "LOG RECALL" with ACCEPT tag blinking and the number of stored logs.
2. Use ▲▼ keys to select between log storage locations "PH" or "EC".
3. Press GLP/ACCEPT to confirm.
4. Use ▲▼ keys to select the lot type (MANUAL, STABILITY or interval ###)
5. With the lot selected, press RANGE/▶ to export to USB flash drive.
LCD displays "PLEASE WAIT" followed by "EXPORTING" with ACCEPT tag and selected lot name (MAN / STAB / ###) blinking.
LCD displays "EXPORTING" and the percentage counter, followed by "DONE" when export is completed. Display returns to the lot selection screen.

Note: The USB flash drive can be safely removed if the USB icon is not displayed. Do not remove the USB drive during export.

Overwriting existing data.

1. When the LCD displays "EXPORT" with ACCEPT and lot number blinking (USB icon displayed), an identical named lot exists on the USB.
2. Press GLP/ACCEPT to continue. LCD displays "OVERWRITE" with ACCEPT tag blinking.
3. Press GLP/ACCEPT (again) to confirm. Not confirming exits the export. Display returns to lot selection screen.

Data Management Warnings

"NO MANUAL / LOGS"	No manual records saved. Nothing to display.
"NO STABILITY / LOGS"	No stability records saved. Nothing to display.
"OVR" with lot ### (blinking)	Identically named lots on USB. Select overwrite option.
"NO MEMSTICK"	USB drive is not detected. Data can not be transferred. Insert or check the USB flash drive.
"BATTERY LOW" (blinking)	When low battery, export is not executed. Recharge the battery.

Logged Data Warnings in CSV file

°C !	Probe used beyond its operation specifications. Data not reliable.
°C !!	Meter in MTC mode.
°C !!!	Meter in NO TC mode. Temperature value only for reference.

13. GLP

Good Laboratory Practice (GLP) allows the user to store and recall calibration data. Correlating readings with specific calibrations ensures uniformity and consistency.

Calibration data is stored automatically after a successful calibration. Saving a new EC calibration automatically clears the existing %NaCl calibration.

- Press RANGE/▶ to select between modes (PH, ORP CONDUCTIVITY, TDS or SALINITY)
- From the measurement screen, press GLP/ACCEPT to view GLP data.
- Use the ▲ ▼ keys to scroll through the calibration data displayed on the third LCD line
- Press ESC or GLP/ACCEPT to return to measurement mode.

GLP information is included with every data log.

pH INFORMATION

pH calibration data displayed on the third LCD line: offset, slope, pH calibration solutions, time, date, calibration expiration time (if enabled in SETUP).

EC/TDS INFORMATION

EC calibration data displayed on the third LCD line: cell factor (C.F.), offset, EC standard solution, temperature coefficient (T.Coef.), temperature reference (T.Ref.), time, date, calibration expiration time (if enabled in SETUP).

NaCl% INFORMATION

Salinity calibration data displayed on the third LCD line: cell factor (C.F.), coefficient, salinity standard solution, time, date, calibration expiration time (if enabled in SETUP)

If the instrument has not been calibrated or calibration has been deleted, the blinking "NO CAL" message is displayed in GLP.

If calibration expiration time is disabled, "EXP WARN DIS" is displayed.



14. TROUBLESHOOTING

SYMPTOMS	PROBLEM	SOLUTION
Slow response / Excessive drift	Dirty pH electrode	pH electrode: Soak the electrode tip in MA9016 for 30 minutes, then follow the Cleaning procedure
	Dirty conductivity probe	EC probe: Remove and clean the sleeve. Make sure the four rings on the probe are clean.
Reading fluctuates up and down (noise)	Clogged/dirty pH electrode junction. Low electrolyte level (refillable electrodes only)	Clean the electrode. Refill with fresh MA9012 electrolyte
	Conductivity probe sleeve not properly inserted; air bubbles inside sleeve.	Make sure the sleeve is correctly placed. Tap the probe to remove air bubbles.
Display shows the reading blinking.	Reading out of range	Recalibrate the meter. Check the sample is within measurable range. Make sure the autoranging feature is not enabled.
Meter fails to calibrate or gives faulty readings	Broken probe	Replace the probe.
LCD tags displayed continuously at startup	ON/OFF key is blocked	Check the keyboard. If error persists, contact Milwaukee Technical Service.
"Internal Er X"	Internal hardware error	Restart the meter. If error persists, contact Milwaukee Technical Service.

15. ACCESSORIES

MA917B/1	Combination pH electrode, glass body, refillable
MA924B/1	ORP probe, glass body, refillable
MA831R	Stainless steel temperature probe
MA814DB/1	4-ring EC/TDS/NaCl/Temperature probe with DIN connector
MA9001	pH 1.68 buffer solution (230 mL)
MA9004	pH 4.01 buffer solution (230 mL)
MA9006	pH 6.86 buffer solution (230 mL)
MA9007	pH 7.01 buffer solution (230 mL)
MA9009	pH 9.18 buffer solution (230 mL)
MA9010	pH 10.01 buffer solution (230 mL)
MA9011	Refilling solution 3.5M KCl for pH/ORP electrodes (230 mL)
MA9012	Refilling solution for pH electrode (230 mL)
MA9015	Storage solution (230 mL)
MA9016	Electrode cleaning solution (230 mL)
MA9020	200-275 mV ORP solution (230 mL)
MA9060	12880 $\mu\text{S}/\text{cm}$ calibration solution (230 ml)
MA9061	1413 $\mu\text{S}/\text{cm}$ calibration solution (230 ml)
MA9063	84 $\mu\text{S}/\text{cm}$ calibration solution (230 ml)
MA9064	80000 $\mu\text{S}/\text{cm}$ calibration solution (230 ml)
MA9065	111.8 mS/cm calibration solution (230 ml)
MA9066	NaCl 100% calibration solution (230 ml)
MA9069	5000 $\mu\text{S}/\text{cm}$ calibration solution (230 ml)
MA9112	pH 12.45 buffer solution (230 mL)
MA9310	12 VDC adapter, 220 V
MA9311	12 VDC adapter, 110 V
MA9315	Electrode holder

CERTIFICATION

Milwaukee Instruments conform to the CE European Directives.



RoHS
compliant



Disposal of Electrical & Electronic Equipment. Do not treat this product as household waste. Hand it over to the appropriate collection point for the recycling of electrical and electronic equipment.

Please note: proper product and battery disposal prevents potential negative consequences for human health and the environment. For detailed information, contact your local household waste disposal service or go to www.milwaukeeinstruments.com (US only) or www.milwaukeeinst.com.

RECOMMENDATION

Before using this product, make sure it is entirely suitable for your specific application and for the environment in which it is used. Any modification introduced by the user to the supplied equipment may compromise the meter's performance. For your and the meter's safety do not use or store the meter in hazardous environment. To avoid damage or burn, do not perform any measurement in microwave ovens.

WARRANTY

This instrument is warranted against defects in materials and manufacturing for a period of 3 years from the date of purchase. Electrodes and Probes are warranted for 6 months. This warranty is limited to repair or free of charge replacement if the instrument cannot be repaired. Damage due to accidents, misuse, tampering or lack of prescribed maintenance is not covered by warranty. If service is required, contact your local Milwaukee Instruments Technical Service. If the repair is not covered by the warranty, you will be notified of the charges incurred. When shipping any meter, make sure it is properly packaged for complete protection.



Milwaukee Instruments reserves the right to make improvements in design, construction and appearance of its products without advance notice.

THANK YOU FOR CHOOSING



Sales and Technical Service Contacts:

Milwaukee Electronics Kft.
Alsó-kikötő sor 11C
H-6726 Szeged - HUNGARY
tel: +36 62 428 050
fax: +36 62 428 051
www.milwaukeeinst.com
e-mail: sales@milwaukeeinst.com

Milwaukee Instruments, Inc.
2950 Business Park Drive
Rocky Mount, NC 27804 USA
tel: +1 (252) 443-3630
fax: +1 (252) 443-1937
www.milwaukeeinstruments.com
e-mail: sales@milwaukeeinstruments.com